

LICON s.r.o.

2024



Quality Function **Design** Tradition



REFERENCES



Sky Tower,
Wrocław, Poland



World of Volvo,
Göteborg, Sweden



Opera House,
Copenhagen, Denmark

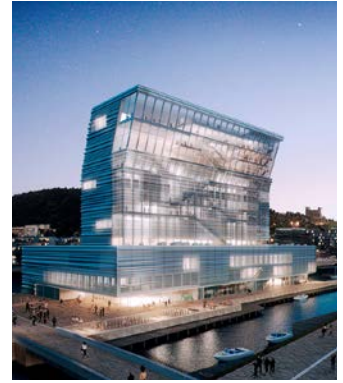

Museum Munch Oslo,
Norway



Lachta Centr,
Saint Petersburg, Russia



Ferring,
Copenhagen, Denmark



Landsbankinn,
Reykjavik, Iceland



Fyrstikkalléen 1 AS Oslo,
Norway



The Circle – airport,
Zurich, Switzerland



MCBA Museum,
Lausanne, Switzerland



Museum HC Andersens,
Odense, Denmark

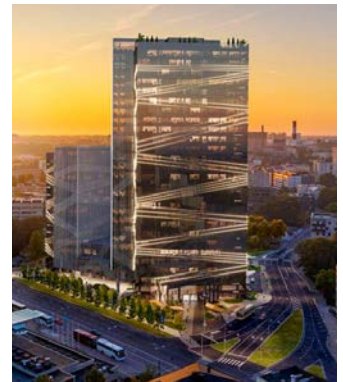

Quartier Arter
Tallinn, Estonia



Einsteinova Business Centre,
Bratislava, Slovakia



Harpa Concert Hall,
Reykjavik, Iceland



Nordea Headquarters,
Copenhagen, Denmark



UBS Pleyad Business Centre
Saint-Denis, France



TRENCHHEATERS
KORAFLEX

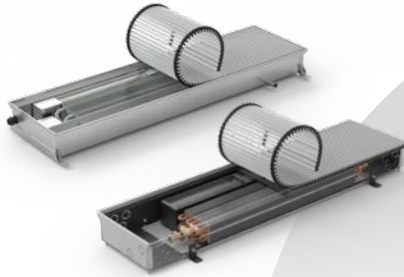

FREE-STANDING
CONVECTORS
KORALINE

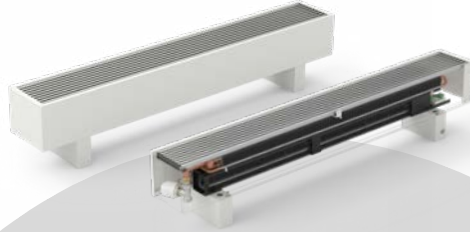

WALL-MOUNTED
CONVECTORS
KORAWALL

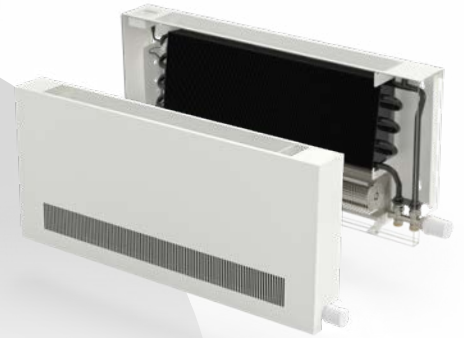

CONVECTORS
WITH FORCED
CONVECTION

FACADE
CONVECTORS
KORASPACE



CONVECTORS
WITH NATURAL
CONVECTION

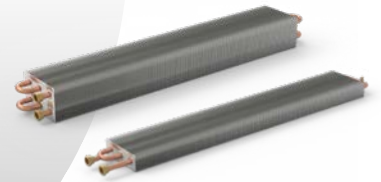

HEAT
EXCHANGERS
KORABASE



TRENCH HEATERS
KORAFLEX



FREE-STANDING
CONVECTORS
KORALINE

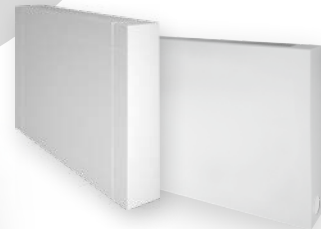

WALL-MOUNTED
CONVECTORS
KORAWALL

NEWS 2024

CENTRAL HEAT RECOVERY
UNITS **VENTBOX**



Clean and
fresh air

PRODUCT PORTFOLIO

We offer a very wide range of products under one brand which enables comprehensive solutions for all types of buildings and spaces, all of which contribute to maximum compatibility, simplicity of design and service, individual solutions and financial savings.

LICON s.r.o.

A 50-year tradition in the manufacture of convection heaters. A member of the KORADO group since 2013. LICON s.r.o. offers tailor-made projects for every type of building. LICON s.r.o. insists on using the most modern research and development methods, and work closely with leading experts in the field, including higher education institutions (the Technical University of Liberec, the Czech Technical University in Prague, etc.). We use the most up-to-date machines for the manufacture of our products, employing the principles of lean production. Products are manufactured in the shortest possible time

while maintaining maximum materials and design quality. LICON s.r.o. is a certified ISO 9001 Quality Management supplier. Our products are manufactured and tested according to ČSN EN 442 and ČSN EN 16430 standards. CE marking indicates that LICON convectors conform to the conditions set out in the Declaration of Performance in accordance with Regulation No. 305/2011 of the European Parliament and of the European Council, and further confirmed by notified authority No. 1015, the Engineering Test Institute, Brno.

LICON s.r.o. convectors are sold all over the world. They are manufactured using the most up-to-date technology at our LICON plant in Liberec, Czech Republic.



Quality for over 50 years



1968

The first LIKOV **steel convectors were manufactured** in Liberec in 1968.



1995

Product portfolio modernisation. **Production of the first trench heaters.**

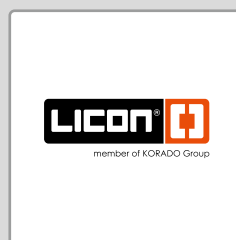

2004

Comprehensive transformation of the company, **replacing the original LIKOV name to LICON HEAT s.r.o.**



2013

LICON HEAT s.r.o. acquired by KORADO.

Why choose LICON convectors?



Ideal for every interior...

Our range includes trench, wall-mounted, free-standing and custom-made convectors. Installation is non-intrusive, including in historical buildings.



Effective heating...

The KORALINE Safe and Max ranges are characterised by a number of safety features that make them ideal for use in schools, healthcare and care facilities.



Extensive range...

Our extensive range of designs caters for every interior, for both humid and dry environments. The range includes convectors that achieve high heat outputs with a design to enhance even the most demanding interior.



Top technology...

Convectors are compatible with heating systems operated with all types of heat sources (heat pumps, gas, electricity, solar heat, wood and biomass), including systems with a low temperature gradient. Convectors provide a safe solution, with a low surface temperature not exceeding 43 °C. KORALINE convectors include a high quality cover grille, including the option of a pencil proof version to ensure increased user safety. Forced convection convectors are 0–10 voltage controlled and powered by 24 V DC.

Easy installation and maintenance...



WINTER heat pump

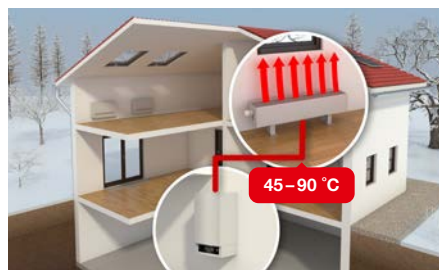

WINTER boilers, hot-water fireplaces, heaters



SUMMER heat pump (dry cooling)

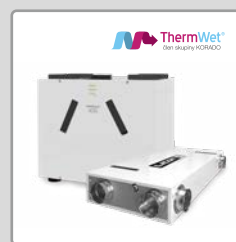
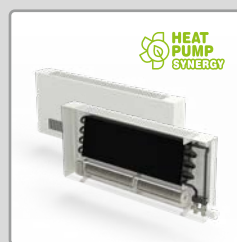

2020

New generation of KORAFLEX trench heaters

2022

The KORALINE free-standing convectors portfolio was significantly expanded to include new types, focusing on safety, design and high performance.

2023

The development of wall-mounted KORAWALL convectors with forced convection has expanded the portfolio to include units achieving high efficiency even at low temperature gradients.

2024

Change of name to LICON s.r.o., merger with the company ThermWet and production start of VENTBOX heat recovery units.

Under the LICON s.r.o. brand, we will continue to improve, develop and offer quality products in the areas of heating, cooling and ventilation.

KORAFLEX

TRENCH HEATERS WITH NATURAL CONVECTION



- 897 standard sizes
- 23 standard lengths
- 4 model lines

- Heat output up to 3 480 W
- 20 standard grilles
- Design solution options

KORAFLEX Optimal FKO with natural convection

Our widest range of trench heaters. Available in Economic and Exclusive versions, may be fitted with the entire range of grilles and frames.



KORAFLEX Thin FKT with natural convection

Trench heater with lowest unit height – 6 cm. This model is particularly suited to interiors with low floor depth. Thin trench heaters may only be fitted with Thin grilles and Thin frames. Available in Economic and Exclusive versions.



KORAFLEX Basic FKB with natural convection

Economic model suitable for design solutions. Manufactured from non-lacquered galvanized steel.

KORAFLEX Pool FKP with natural convection

For humid environments, manufactured from AISI 316 stainless steel finished with hem, RAL 9006 grey lacquered heat exchanger.

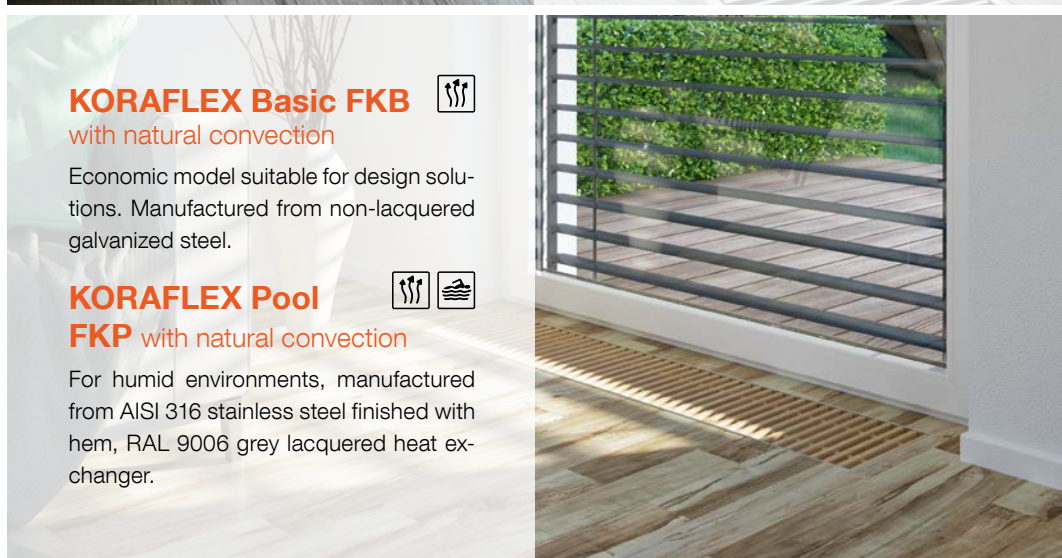

KORAFLEX

TRENCH HEATERS WITH FORCED CONVECTION



- 180 standard sizes
- 12 standard lengths
- 3 model lines
- Heat output up to 13 435 W
- Cooling output up to 1 035 W
- 20 standard grilles
- Safe regulation guaranteeing precise fan rotation and declared output
- 24 V DC or 230 V AC regulation
- Design solution options



KORAFLEX Pool-V FVP with forced convection

Model line for humid environments. Made of AISI 316 stainless steel, with sloping base and dividing partition as protection against flooding. Swimming pool model may be fitted with aluminium grille. Pool trench heaters are finished with hems replacing frames.



Unsuitable for salt water pools.



KORAFLEX Optimal-V FVO with forced convection

Our widest range of 24 V DC powered trench heater models with forced convection. Available in Economic and Exclusive versions, fitted with RAL 9005 black lacquered heat exchangers. The KORAFLEX Optimal range may be fitted with the entire range of grilles.



KORAFLEX Energy FVE with forced convection

Derived from the Optimal range, extended by 20 cm, housing electrical regulation and 230 V AC connection. Suitable for dry environments for heating only. Installation of the device must be carried out by persons with the relevant electro technical qualifications. Proper inspection and testing of the electrical installation must be carried out prior to commissioning.

KORAFLEX HEATING AND COOLING

TRENCH HEATERS WITH FORCED CONVECTION

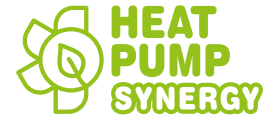

- 17 standard sizes
- 14 standard lengths
- 2 model lines

- Heat output up to 10 745 W
- Cooling output up to 2 180 W
- Design solution options



KORAFLEX Variant F2V model, heating or cooling 2-pipe system

For heating or cooling. Achieves high heating and cooling performance. The F2V model is fitted with a stainless steel condensation drainage canal.



KORAFLEX Variant F4V heating and cooling 4-pipe system

For heating and cooling. Achieves high heating and cooling performance. Equipped with a stainless steel condensation drainage canal. Available in Economic and Exclusive models.

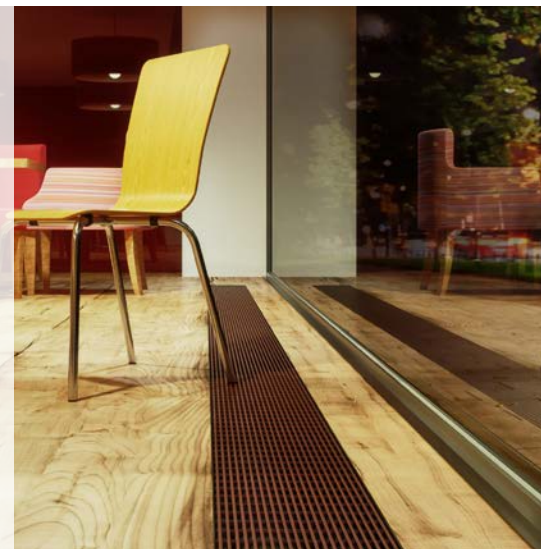

KORAFLEX GRILLES

Aluminium elox

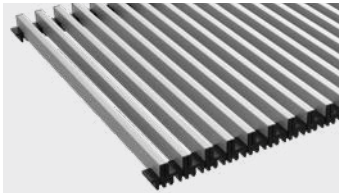

Roll-up alu/silver

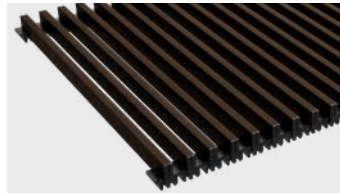

Roll-up alu/dark bronze



Roll-up alu/light bronze

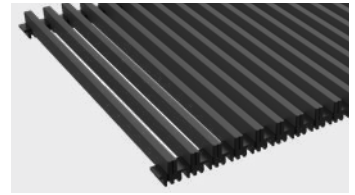

Roll-up alu/black

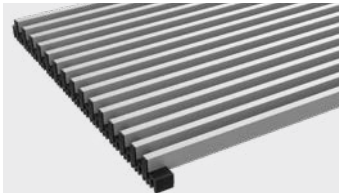

Linear alu/silver

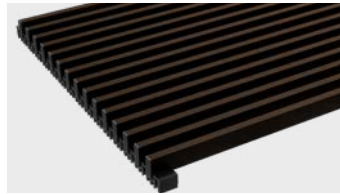

Linear alu/dark bronze

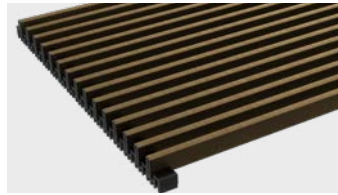

Linear alu/light bronze

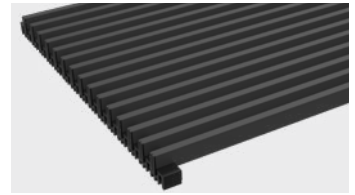

Linear alu/black

Thin – aluminium elox

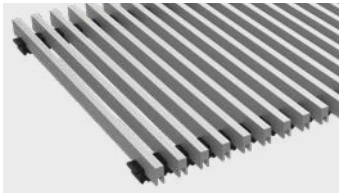

Roll-up alu/silver

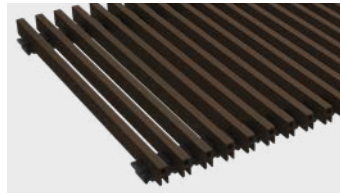

Roll-up alu/dark bronze

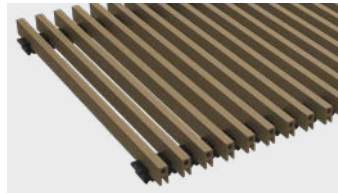

Roll-up alu/light bronze

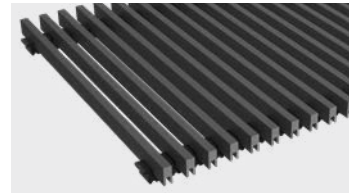

Roll-up alu/black

Wood



Roll-up natural/lacquered beech



Roll-up natural/lacquered oak



Roll-up natural/lacquered mahogany (upon request)

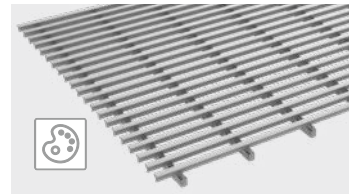

Cross/steel, RAL 9006 lacquer (upon request)

Cross

Steel

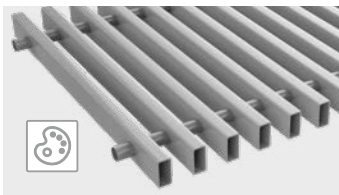

Roll-up steel, RAL 9006 lacquer

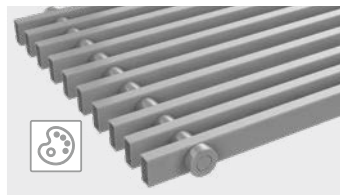

Linear steel, RAL 9006 lacquer

Stainless steel

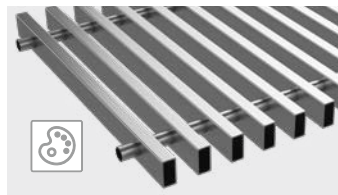

Roll-up/stainless steel

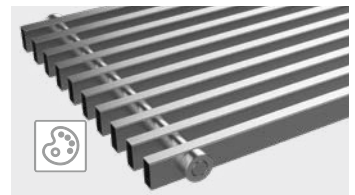

Linear/stainless steel

KORAFLEX FRAMES

U-frame

Standard

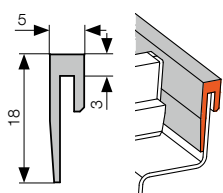

F-frame

Optional

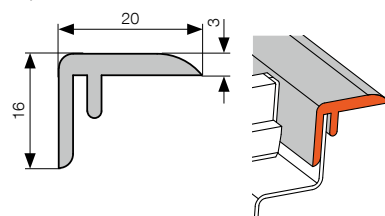

Thin frame

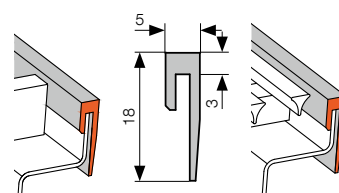

Lowered casing edge

Cross frame

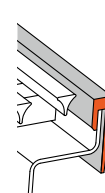

Hem

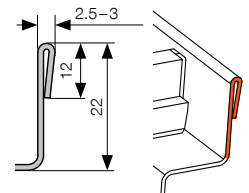

Measurements in mm.

DESIGN MODULES

TRENCH HEATERS

Our modular system was developed to simplify the installation of trench heaters in unusual interiors, and to enable rapid processing of orders and quotations for projects. Modules are design elements

only – they are not fitted with heat exchangers. **The wide range of design modules means quick and easy selection of trench heater systems made to suit your particular interior.**

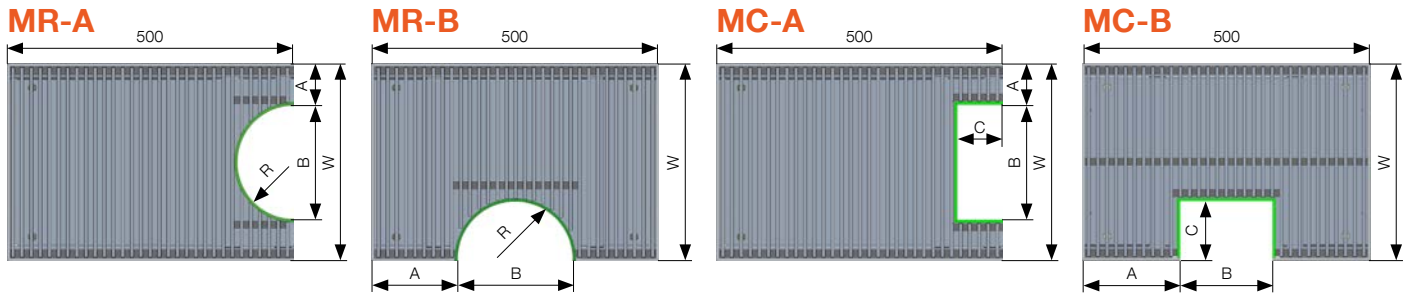

RAISED FLOOR INSTALLATIONS



Raised floor supports offer a stable and effective solution for raised floor trench heater installations. Supports are made of non-lacquered

steel, are suitable for raised floors for a depth of up to 500 mm and can be used with trench heaters with both natural or forced convection.

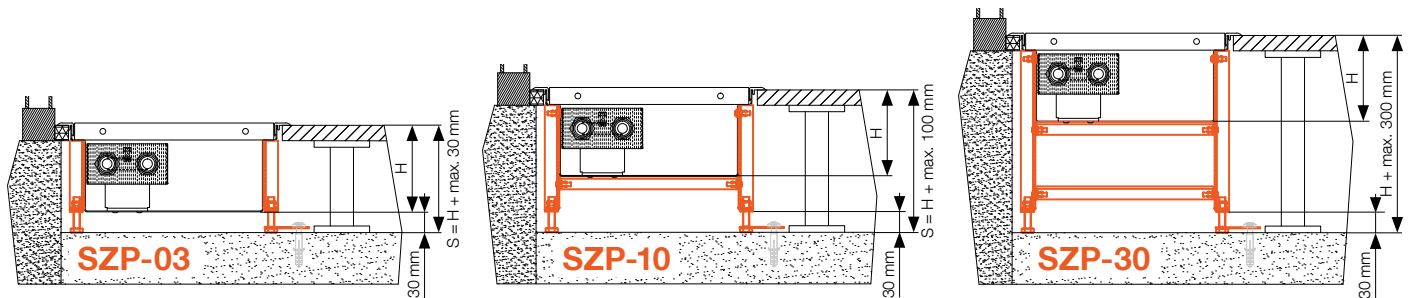

AIR CONDITIONING CONNECTIONS

TRENCH HEATERS

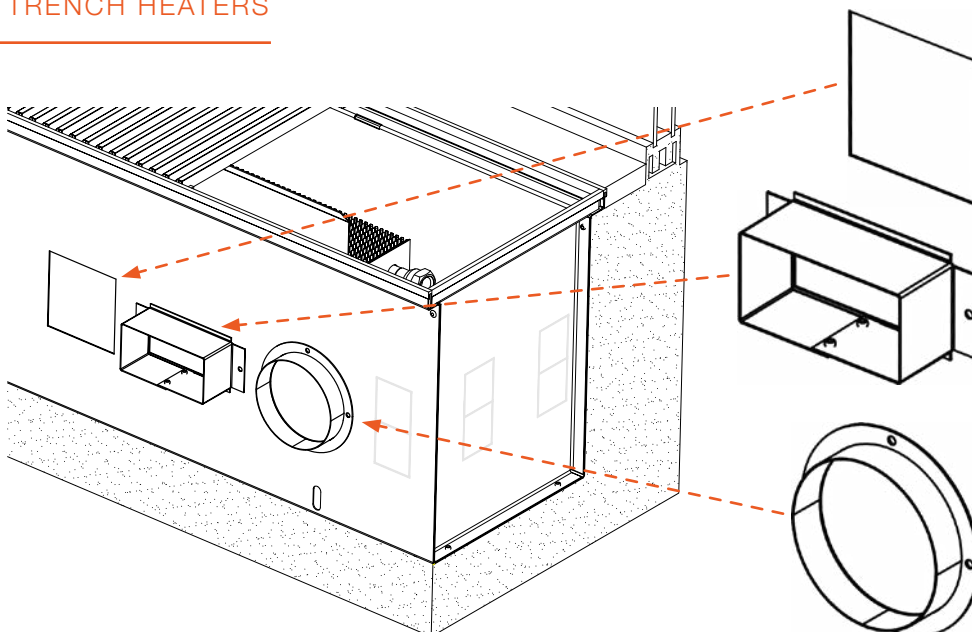

Opening for air conditioning connection

- optional alteration to construction
- measurements as per specifications
- quotation on request

Rectangular flange

- optional accessory
- measurements as per specifications
- quotation on request

Circular flange

- optional accessory
- measurements as per specifications
- quotation on request

CORNER PARTS

Corner parts are the ideal solution to ensure seamless connections of KORAFLEX trench heaters in the corners of rooms. Corner parts are design elements only – they are not fitted with heat exchangers.

MA-A

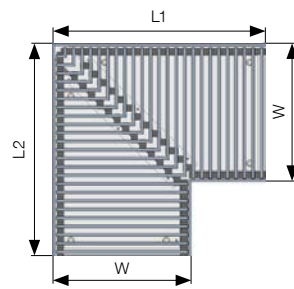

MA-B

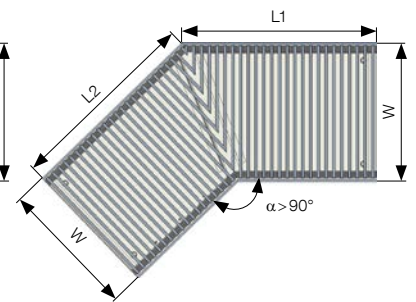

ANGLED AND CURVED DESIGNS

Unified style and technical design for every interior, elegant continuous convectors along the walls of an entire room, available in angled and curved designs. These elements are equipped with heat exchangers.

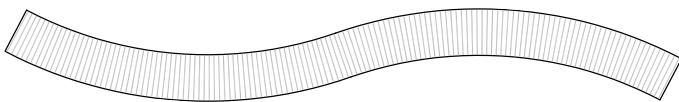

REALIZATION EXAMPLE

Opera House, Copenhagen, Denmark

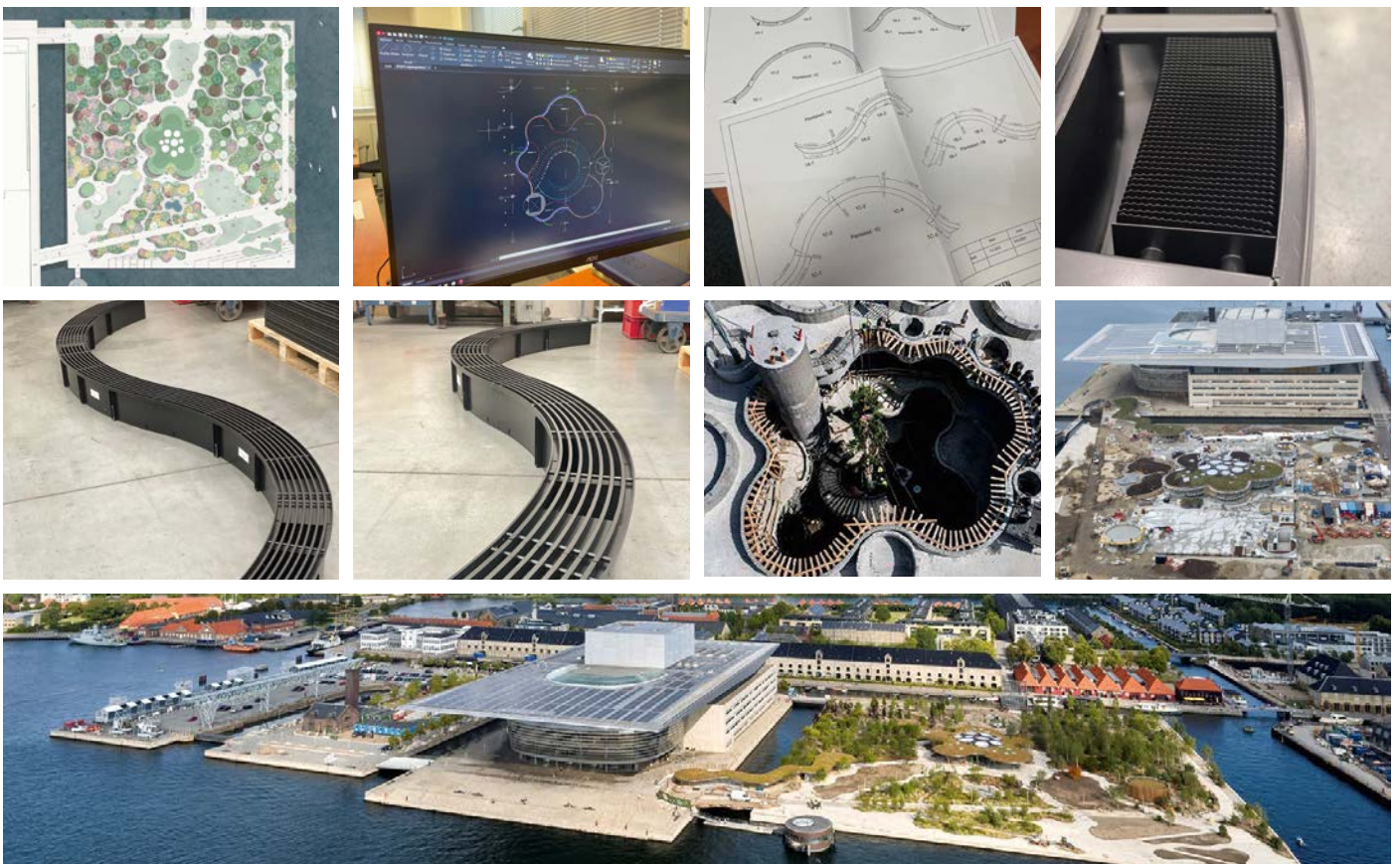

KORALINE

FREE-STANDING CONVECTORS WITH NATURAL CONVECTION AND DESIGN GRILLE

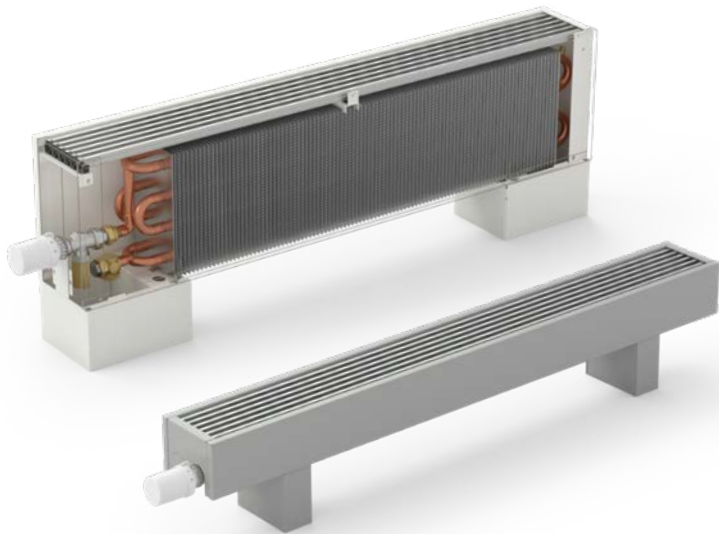

- 756 standard sizes
- 16 standard lengths
- 2 model lines
- Heat output up to 7 400 W
- May be installed on the floor or walls
- Low surface temperature
- High heat output
- Modern design

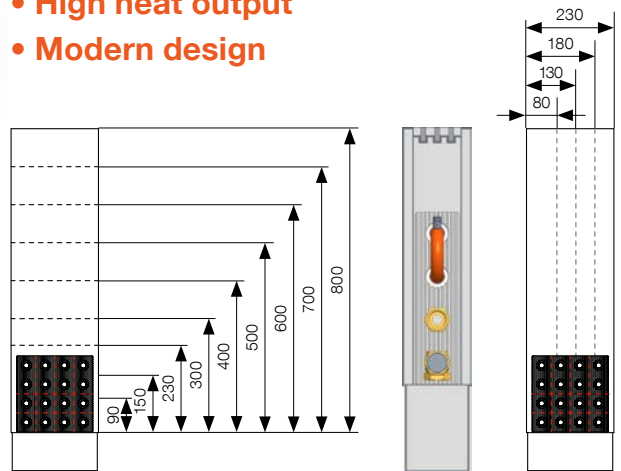

KORALINE Optimal LKO with natural convection

Are characterized by design and output. They are fitted with a high quality silver elox aluminium grille. Given the diverse portfolio and the optimal output, convectors in this model line are ideal for heating private houses, residential and office buildings.



KORALINE Power LKW with natural convection

Is the most extensive model line and features a high-performance heat exchanger with double the standard area of uniquely shaped fins. This model line provides high heat output while maintaining a modern design. Convectors are fitted with a high quality silver elox aluminium grille.



KORALINE

FREE-STANDING CONVECTORS WITH NATURAL CONVECTION AND PERFORATED SAFETY GRILLE

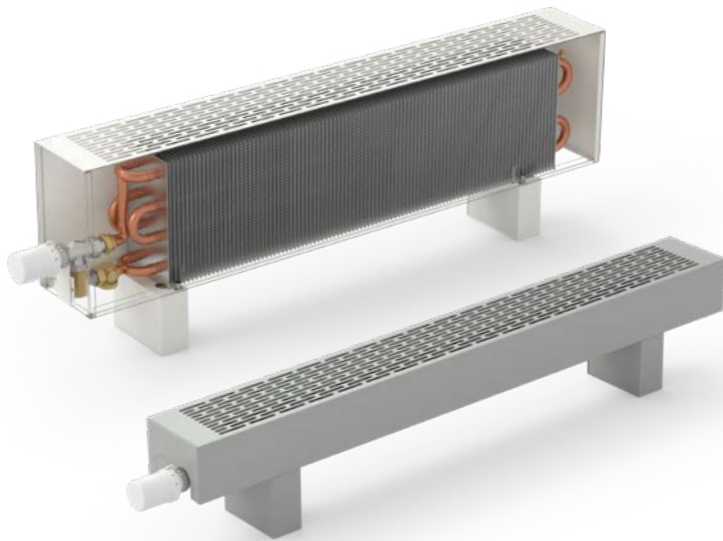

- 480 standard sizes
- 16 standard lengths
- 2 model lines
- Heat output up to 7 400 W
- May be installed on the floor or walls
- Low surface temperature
- High heat output
- Perforated safety grille

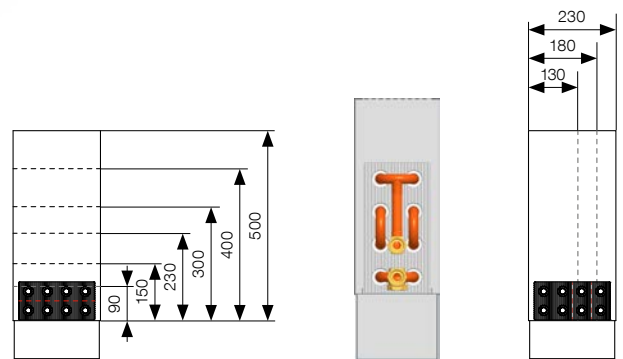

KORALINE Basic LKB with natural convection

Is the standard version of our low surface temperature free-standing convectors. In this model line the safety grille is perforated directly in the galvanized steel casing. Optimal outputs and a favourable price make KORALINE Basic the ideal model line for eating private homes, apartment complexes and office buildings.



KORALINE Combi LKC with natural convection

KORALINE Combi LKC models house a high performance heat exchanger with double the standard area of fins. A safety grille is an integral part of the casing – it is perforated directly in the galvanized steel casing body. Thanks to their compact dimension, maximal output, and low surface temperature, the KORALINE Combi LKC model is suitable for heating a variety of interiors starting from small family houses up to large public premises.

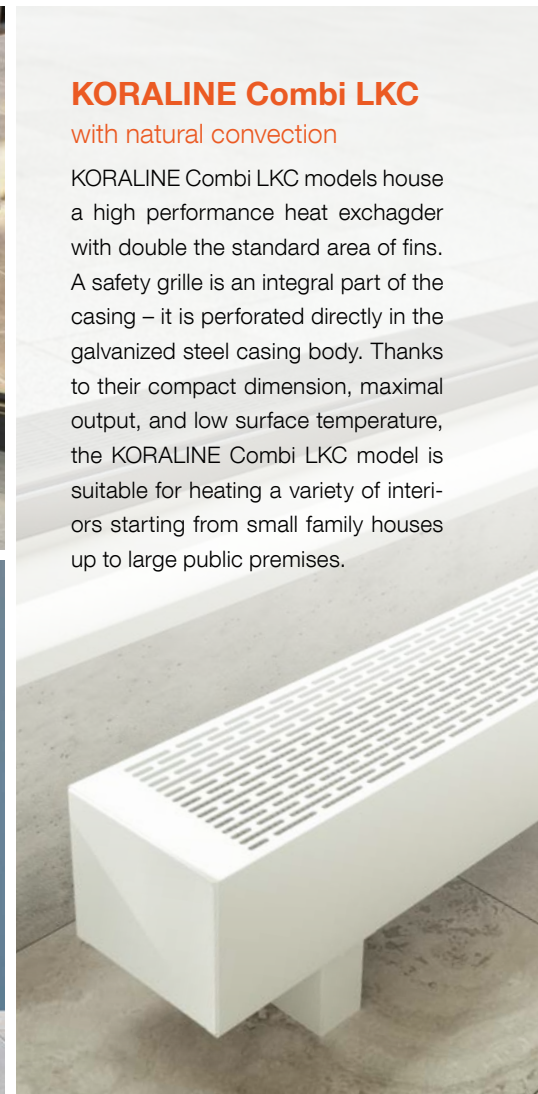

KORALINE

FREE-STANDING CONVECTORS WITH NATURAL CONVECTION
WITH SYMMETRIC SAFETY PENCILPROOF GRILLE AND RESISTANT DESIGN

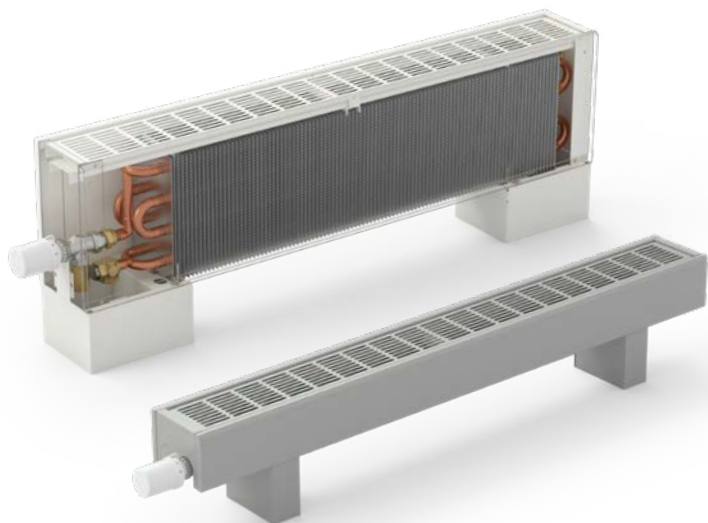

- 561 standard sizes
- 11 standard lengths
- 2 model lines
- Heat output up to 5 096 W
- May be installed on the floor or walls
- Low surface temperature
- High heat output
- Emphasis on safety

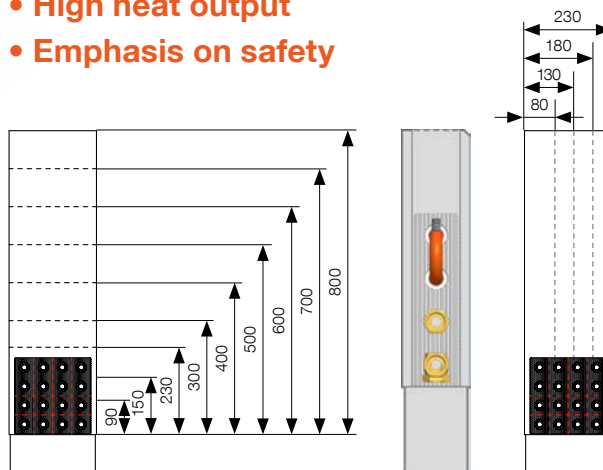

KORALINE Safe LKS with natural convection

For safety reasons, the convector casing is made of 1.5 mm thick sheet steel, its front edge is bevelled, and is fitted with a symmetric pencil-proof grille. Thanks to its safety features and low surface temperature, this model line is ideal for installation in educational, healthcare, administrative and public premises.



KORALINE Max LKM with natural convection

This line features a combination of heightened safety level and maximum output. The casing is made of 1.5 mm thick sheet steel and is equipped with a symmetric pencil-proof grille. The body houses a high-performance heat exchanger with double the standard area of aluminium fins.



KORALINE

FREE-STANDING CONVECTORS WITH FORCED CONVECTION

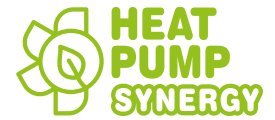

- 12 standard sizes
- 6 standard lengths
- 1 model lines
- Heat output up to 6 061 W
- May be installed on the floor
- Low surface temperature
- Version with forced convection
- High heat output

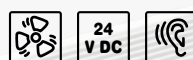
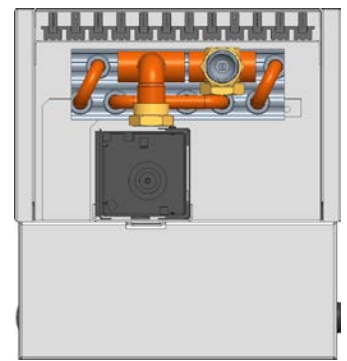
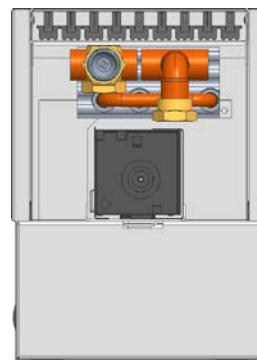

KORALINE Optimal-V LVO with forced convection

An exclusive version of free-standing convectors fitted with economical 24 V DC fans with minimum power input. Achieves very high performance even with low temperature gradients. The model is available, equipped with aluminium grilles.

KORALINE

BENCH CONVECTOR WITH WOODEN BENCH TOP



- 12 standard sizes
- 6 standard lengths
- 2 model size ranges
- Heat output up to 3 525 W
- Solid wood or veneer bench tops
- 3 bench top wood options: beech, oak or American walnut
- Version for damp/humid environments
- High heat output
- Sophisticated design

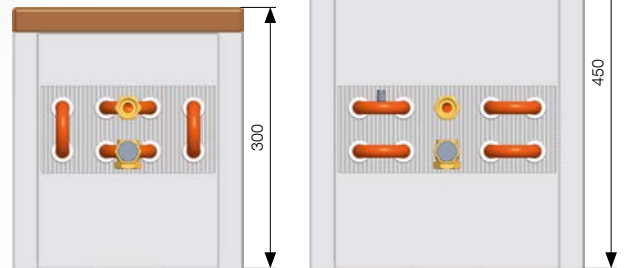

KORALINE Optimal LDO with natural convection

Bench convectors fitted with beech, oak or American walnut bench tops. Manufactured from RAL 9016 white lacquered galvanized sheet steel. Designed for dry environments in halls or administrative buildings. Built to bear static weight and suitable for sitting.

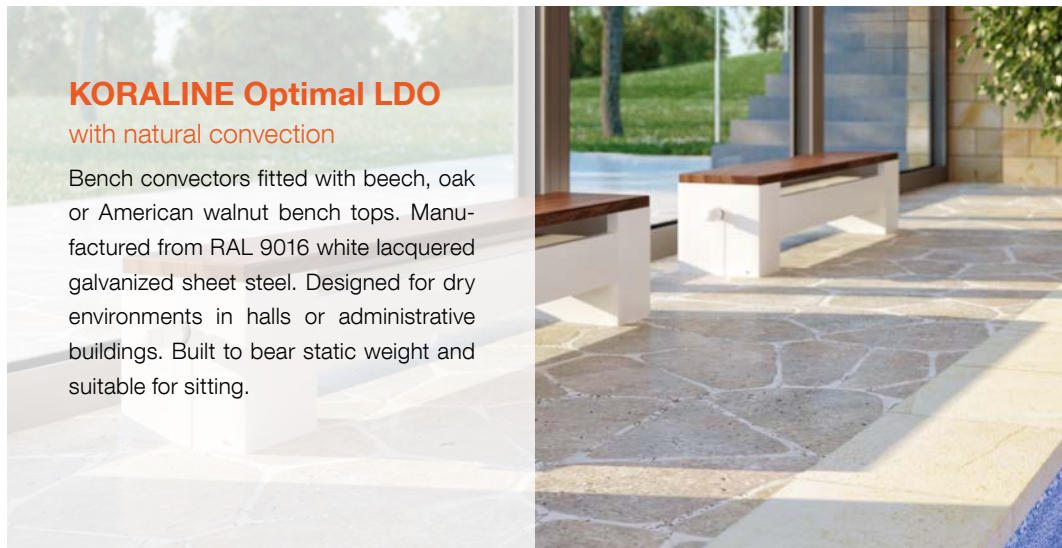

KORALINE Pool LDP with natural convection

A proven smart combination of design, performance and characteristics. KORALINE Pool LDP is fitted with RAL 9016 white lacquered AISI 316 stainless steel casing. Where fitted with American walnut bench tops, this model is suitable for installation in environments with increased humidity.

KORAWALL

WALL-MOUNTED CONVECTORS

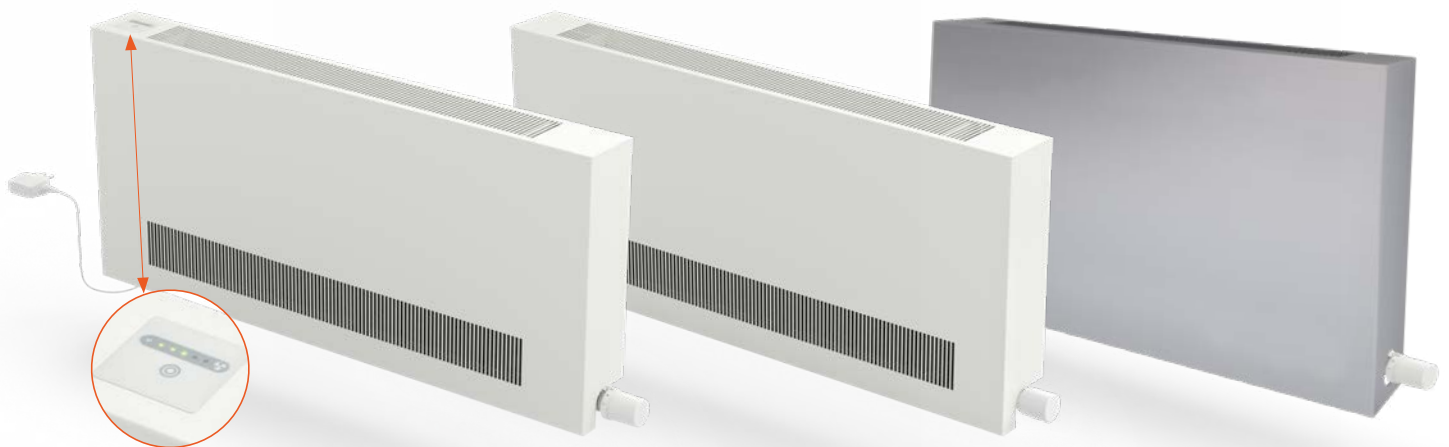
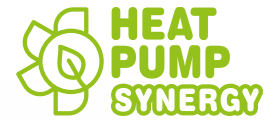

- 57 standard sizes
- 7 model size ranges
- Heat output up to 8 960 W
- Cooling output up to 1 419 W
- Heating and cooling functions
- Models with forced and natural convection

KORAWALL Optimal WKO



with natural convection

Wall-mounted convectors have long been used in households and commercial premises. They achieve high performance even though they are small in size. KORAWALL convectors feature a very low and safe surface temperature.



KORAWALL Direct WVD



Wall-mounted convector with forced convection, autonomous control and 24 V DC connection

KORAWALL Energy WVE



Wall-mounted convector with forced convection, autonomous control and 230 V AC connection

Highly efficient wall-mounted convectors suitable for use with heat pumps. The convectors are equipped with autonomous control with an integrated keyboard, which allows the fans to be regulated directly on the units. Connection to the electrical network is via a prepared terminal block, which is safely built inside the heating body or via a network adapter directly into the electrical socket.

KORAWALL Optimal-V WVO, Pool-V WVP



with forced convection

Developed for low-temperature heating systems. High performance is guaranteed even at very low temperature gradients. Ideal for installation where the heat source is a heat pump, solar system or condensing boiler. In the summer months they can be used for cooling without causing condensation.



KORABASE

HEAT EXCHANGERS

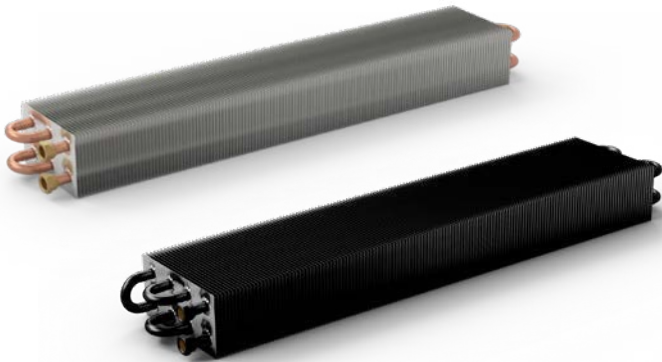

- 168 standard sizes
- 12 standard lengths
- 7 size ranges
- Heat output up to 5 500 W
- Design solution options
- Counter-flow and single-stream connections



KORASPACE

FACADE CONVECTORS



- Optional colours available according to RAL colour chart
- Design solution options



KORABASE Economic, Exclusive

KORABASE heat exchangers are suitable for individual installations, especially in spaces where uniformity of interior design materials is paramount. Heat exchangers are manufactured from copper tubes and aluminium fins. Exclusive version is lacquered black RAL 9005.



KORASPACE FK with natural convection

Facade convectors are an ideal and effective solution for buildings with large all-glass facades, when the transmission of cold air during the winter months may significantly affect the microclimate of the interior. KORASPACE facade convectors are installed directly onto the facade, thereby preventing the direct transmission of cold air into the interior of the building. Warm air rising from the convector mixes with descending

cool air to create a thermal barrier, providing greater comfort without causing condensation on the surface of the glass.

- Excellent controllability and rapid temperature rise
- No transmission of heat to the exterior of the facade
- Space for further, parallel distribution systems



COLOUR CHART

			
code 10 White RAL 9016	code 39 Black RAL 9005	code 59 White texture RAL 9016	code 60 Black texture RAL 9005
			
code 14 Jasmine	code 16 Bahama	code 22 Manhattan	code 26 Pergamon
			
code 32 Anthrazit Metallic	code 35 Silber RAL 9006	code 37 Red RAL 3001	code 40 Alloy Black
			
code 42 Gold	code 45 Pearl Brown	code 47 RAL 9007	code 48 RAL 9006
			
code 49 RAL 7024	code 51 RAL 7016	code 54 RAL 7015	code 57 RAL 7040

Notice: Potentially, there may be variations in colour hues between the colour chart and actual heating units. The standard colour version is white RAL 9016 or black RAL 9005. Other colours shown in the Colour Chart may be ordered at an extra charge according to the valid price list.



LICON s.r.o.
Svárovská 699, Průmyslová zóna Sever, 463 03 Stráž nad Nisou, Czech Republic
e-mail: info@licon.cz, www.liconheat.news, www.licon.cz
Ev. č. 04-2024-CZ